

Timber Trailer



Original Operator's Manual Copyright by Binderberger GmbH



Read the operating instructions carefully before
commissioning the machine!

This manual is valid for:

Model	Article number*
RW 5 Eco	RW-E05-xx
RW 8 Eco	RW-E08-xx
RW 10 Eco	RW-E10-xx
RW 12 Eco	RW-E12-xx
RW 8 Alpin	RW-A08-xx
RW 10 Alpin	RW-A10-xx
RW 12 Alpin	RW-A12-xx
RW 14 Alpin	RW-A14-xx
RW 16 Alpin	RW-A16-xx
RW 18 Alpin	RW-A18-xx
RW 21 Alpin	RW-A21-xx

*The last two digits of the Article number are dependent on the crane version selected

Version of this manual: RW 3.0

Creation date: 2020-12

Table of Contents

1	EC Declaration of Conformity	5
2	Safety instructions	6
2.1	Explanation of symbols	6
2.2	Pictograms and their meaning:	7
2.3	Keep information available	8
2.4	General safety instructions	8
2.5	Intended use	8
2.6	Operator requirements	9
2.7	Alterations to the machine.....	10
2.8	Environmental protection	10
2.9	Limits of use	11
2.10	Residual risks	11
3	Machine description	12
3.1	Functionality.....	12
3.2	Overview	13
3.3	Technical Data	14
3.4	Equipment.....	16
4	Transportation	17
4.1	Safety instructions during transport	17
4.2	Transportation of the machine	18
5	Set up of the machine	19
5.1	Safety instructions for installation of the machine	19
5.2	Duties before starting operation.....	20
5.3	Electrical supply.....	20
5.4	PTO drive	21
5.5	Tractor hydraulics.....	21

- 5.6 Crane support..... 22
- 5.7 Extendable frame (mechanically)..... 23
- 5.8 Extendable frame (Telematic)..... 23
- 5.9 Standing platform..... 24
- 5.10 Parking brake..... 24
- 5.11 Swap bodies 25
- 6 Operation..... 26
 - 6.1 Safety instructions during operation..... 26
 - 6.2 Important instructions during operation 27
 - 6.3 Hydraulic braking system 28
 - 6.4 Air brake system..... 29
 - 6.4.1 Release valve:..... 29
 - 6.4.2 Load dependant brake booster:..... 30
 - 6.5 Combined brake system (hydraulic and airbrake) 30
 - 6.6 Cable winch (optional): 31
 - 6.7 Crane position for transport..... 32
 - 6.8 Swivel drawbar 33
 - 6.9 Wheel hub drive (optional) 34
 - 6.10 Stanchion extension (optional) 34
- 7 Shutdown..... 35
 - 7.1 Safety instructions for the shutdown procedure 35
 - 7.2 Crane position 36
 - 7.3 Switch off drive 36
 - 7.3.1 PTO drive 36
 - 7.3.2 Tractor hydraulics..... 36
 - 7.4 Parking brake..... 36
- 8 Maintenance..... 37

8.1	Safety instructions during maintenance	37
8.2	Important instructions during maintenance	38
8.3	Instructions for work on electrical equipment.....	39
8.4	Instructions for work on hydraulic equipment.....	39
8.5	Daily maintenance.....	39
8.6	Duties before finishing maintenance	40
8.7	Cleaning.....	40
8.8	Lubrication plan.....	41
8.9	Checking the tires.....	42
8.10	Chassis and Brakes	42
8.11	Maintenance work every 250 hours	43
8.12	Oil change.....	43
8.13	Changing Oil filter.....	44
8.14	Changing the hydraulic hoses:	44
8.15	Electrical system.....	45
9	Guarantee and Warranty.....	46
10	Conduct when dealing with accidents	47
11	Notes.....	48

1 EC Declaration of Conformity

We hereby declare that the machine, in its different technical implementations, corresponds to the regulations of the Machinery Directive 2006/42/EC and any additionally related standards.

Each of the respectively included safety regulations and manuals are applicable to these machines.

The machines may not be altered. In the case of an alteration to the machine that is not verified by us, this declaration is rendered invalid.

Operation without the appropriate safety devices is not permitted, as the lack of safety devices would no longer comply with the CE directives and would additionally increase the risk of injury.

The name and address of the person who is authorised to compile the technical documentation is as follows:

St. Georgen am Fillmannsbach, 2020

Karl Binderberger

CEO

Binderberger Maschinebau GmbH
Fillmannsbach 9
AT-5144 St. Georgen am Fillmannsbach

2 Safety instructions

2.1 Explanation of symbols

Please pay attention to the meaning of the following symbolic explanations and instructions description. They are divided into levels of risk and classified in accordance with ISO 3864- 2









DANGER	
	<i>Indicates an immediate threat of danger. If the information is not followed, death or serious bodily injury (invalidity) is the result.</i>

WARNING	
	<i>Indicates a potentially dangerous situation. If the information is not followed, death or serious bodily injury (disability) are the result</i>

CAUTION	
	<i>Indicates a potentially dangerous situation. If the information is not followed, material damage as well as minor or moderate physical injuries are the result.</i>

NOTICE	
	<i>Indicates general instructions, useful operator instructions and working recommendations that have no influence on the safety and health of personnel.</i>

2.2 Pictograms and their meaning:

	<p><i>Read the operating instructions carefully before commissioning!</i></p>
	<p><i>During operation, ear protectors and protective glasses must be worn!</i></p>
	<p><i>During operation, safety shoes (with steel cap) are to wear!</i></p>
	<p>Note that the machine may only be operated by one person!</p>
	<p><i>Warning of hazardous electrical voltage</i></p>
	<p><i>Risk of injury due to stumbling</i></p>
	<p><i>Risk of injury due to slipping</i></p>
	<p><i>Warning against hot media</i></p>
 <p>Schmierstelle lubrication point</p>	<p><i>Lubrication point</i></p>

2.3 Keep information available

These operating instructions must be kept with the machine. It must be ensured that all persons who have to carry out activities on the machine can read the operating instructions at any time. All safety instruction signs and operating instruction signs on the machine must always be kept in a clearly legible condition. Damaged or illegible signs must be replaced immediately.

2.4 General safety instructions

The machine may only be operated by people who are trained, instructed and authorised for its use. These people must know the operating instructions and act in accordance with them. The respective competences of the operating personnel are clearly defined.

Operating personnel undergoing training may only initially work with the machine under the supervision of an experienced person. The completed and successful instruction is to be confirmed in writing.

2.5 Intended use

Our timber trailers are designed exclusively for the transportation of logs. The maximum permissible overall weight shall not be exceeded. All other forms of usage do not comply with the intended use. The manufacturer is not responsible for any personal injury or material damage that originates from non-compliant usage, but rather the operator of the machine is!

The reading of this manual as well as the observance of all instructions contained within it, particularly the safety instructions, also comply with the intended use. Also included is the fact that all inspection and servicing work is to be conducted in the prescribed time intervals.

2.6 Operator requirements

No special knowledge of mechanical or electrical engineering is necessary for the operation of the machine. Nevertheless, the operator must be at least **18 years** old. Before the machine is operated for the first time, the user must be trained by the operator of the machine and instructed accordingly. Protective shoes and close-fitting clothing are to be worn during the operation of the machine.

In instances where - servicing works is to be carried out; the operator must possess the necessary technical expertise.

After training, the operator must be able to perform the following activities independently:

- Inspection of the safety equipment at the start and during work.
- Elimination of malfunctions for which no professional training in mechanical or electrical engineering is necessary.

2.7 Alterations to the machine

For safety reasons, no unauthorised alterations may be conducted on the machine, this is also valid for welding work on load-bearing parts. All planned alterations must be approved in writing by the Binderberger company.

Only use original replacement parts / original wear parts / original accessories - these parts are specially designed for the machine. With externally manufactured parts, it is not guaranteed that they have been designed and manufactured to fulfil the operational stress and safety demands.

Parts and additional equipment that have not delivered by us are also not authorised by us for use in the machine.

2.8 Environmental protection

During all work at and with the machine, the regulations for waste avoidance and for proper waste recycling and disposal must be observed.

Particularly during installation and maintenance work, as well as when decommissioning, it must be ensured that substances hazardous to groundwater - such as grease, oils, cleaning fluids containing solvents, etc. do not pollute the ground or enter the sewage system. These substances must be collected in suitable containers and disposed of.

2.9 Limits of use

Only a single, trained operator is allowed to stay within the danger zone during operation. All requirements for the operator are defined in the previous chapter.

During operation, the operator must not be in the danger zone or reach into a dangerous area. The danger area is defined as a radius of 25 m from the trailer. The only permitted area in this radius is the operator's workstation.

The machine may only be set up and operated on a horizontal and firm surface.

The machine may only be operated under perfect lighting conditions (daylight or suitable full illumination) never in poor visibility conditions (thick fog, dusk, darkness).

The machine should only be operated in dry weather, never in heavy rain, heavy snowfall, hail, thunderstorm, extreme heat or cold.

The trailer must be loaded in such a way that the permissible axle and support loads are respected. These can be found in the vehicle documents (if typified) or on the nameplates.

2.10 Residual risks

Despite the correct application of all the machine's safety regulations, residual risks can still occur. These mostly result from incorrect use of the machine.

- Touching rotating or moving components
- Injury from falling wood or machine parts
- Hearing damage from working without hearing protection
- Human misconduct
 - Excessive physical exertion
 - Mental overload
 - Entering a danger area
 - Distractions
 - Neglected control activities

3 Machine description

3.1 Functionality

The Binderberger timber trailer is a stable and durable companion in forestry.

A large number of weight classes and options are available for each timber trailer. The equipment can be put together individually and offers a solution for every customer requirement.

The main task of the timber trailer is to transport logs in large quantities in difficult terrain. To make loading easier and safer, in most cases a crane with hydraulic supports is attached. The crane is supplied with oil either via the tractor hydraulics or via its own hydraulic pump, driven by the tractor's PTO shaft.

In order to be as flexible as possible for the different sizes of the tree trunks, there is the option of a rear extension. This allows the loading area length of the timber trailer to be significantly extended.



3.2 Overview

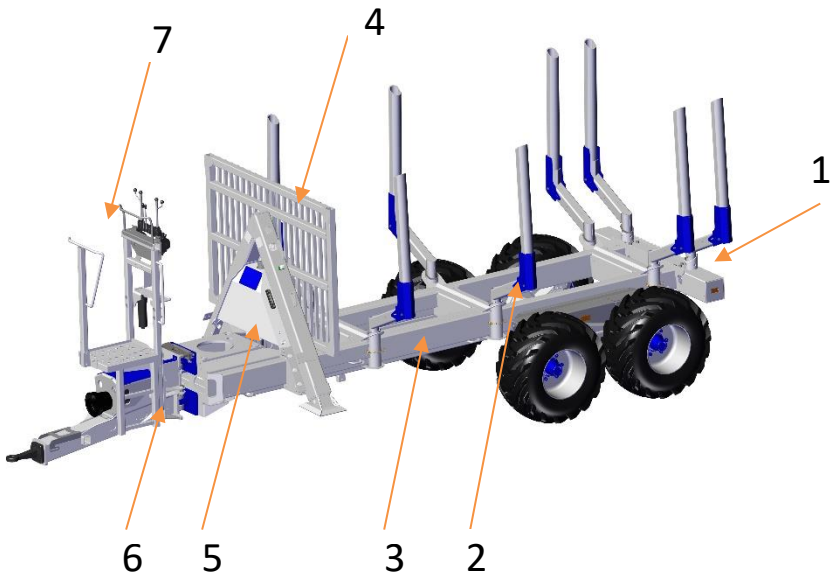

Pos.	Part Name
1	Frame extension
2	Stanchions
3	Frame
4	Front bars
5	Hydraulic tank
6	Swivel drawbar
7	Standing platform

3.3 Technical Data

Model	RW5 eco	RW8 eco	RW10 eco	RW12 eco
Perm. Total weight*	5 t	8 t	10 t	12 t
Payload*	3,6 t	5,7 t	7,6 t	9,5 t
Max. Loading area cross-section*	1,5 m ²	2,1 m ²	2,1 m ²	2,1 m ²
Max. Loading volume, extension extended*	5,6 m ³	9,7 m ³	9,7 m ³	10,3 m ³
Loading area length extension retracted	3,7 m	3,7 m	3,7 m	3,7m
Loading area length extension extended	---	4,6 m	4,6 m	4,9 m
Hydr. Brake	2-Wheels		4-Wheels	
2-cylinder swivel drawbar	---	serial		
Aluminium stanchions	3 Pairs			
Wheels – dimension	400/60- 15,5			
Width	2000 mm	2130 mm	2130 mm	2130 mm

*... the stated dimensions and weights are reference values

Model	RW8 alpin	RW10 alpin	RW12 alpin	RW14 alpin
Perm. Total weight*	8 t	10 t	12 t	14 t
Payload*	5,7 t	7,6 t	9,5 t	11 t
Curb Weight	2,3 t	2,4 t	2,5 t	3 t
Max. Loading area cross-section*	2,1 m ²	2,1 m ²	2,1 m ²	2,4 m ²
Max. Loading volume, extension extended*	9,7 m ³	9,7 m ³	10,3 m ³	11 m ³
Loading area length extension retracted	3,7 m	3,7 m	3,7 m	3,7 m
Loading area length extension extended	4,6 m	4,6 m	4,9 m	4,6 m
Hydr. Brake	2-Wheels	4-Wheels		
2-cylinder swivel drawbar	serial			
Aluminium stanchions	4 Pairs			
Wheels – dimension	400/60- 15,5			500/50-17
Width	2130 mm			2340 mm

Model	RW16 alpin	RW18 alpin	RW21 alpin
Perm. Total weight*	16 t	18 t	21 t
Payload*	12,1 t	13,9 t	16,8 t
Curb Weight	3,9 t	4,1 t	4,2 t
Max. Loading area cross-section*	2,7 m ²	2,7 m ²	2,7 m ²
Max. Loading volume, extension extended*	13,5 m ³	13,5 m ³	14,3 m ³
Loading area length extension retracted	4,1 m	4,1 m	4,1 m
Loading area length extension extended	5 m	5 m	5,3 m
Hydr. Brake	4-Wheels		
2-cylinder swivel drawbar	serial		
Aluminium stanchions	5 Pairs		
Wheels – dimension	550/45- 22,5	550/45- 22,5	560/45- 22,5
Width	2520 mm	2520 mm	2540 mm

3.4 Equipment

There is a multitude of options to choose from for every timber trailer. The equipment can be put together individually and offers a solution for every customer requirement.

Options include:

- axle drives
- Type of support
- tires
- braking system
- Drawbar and standing platform
- Suspension and slope compensation
- Mechanical / hydraulic frame extension (Telematic)
- typing
- Swap bodies
- Various types of cranes
- Various additional equipment and minor changes

4 Transportation

4.1 Safety instructions during transport

WARNING	
	<p style="text-align: center;"><u>Risk of injury during transport!</u></p> <ul style="list-style-type: none">• <i>Care must be taken to ensure that nobody is in the danger area and a sufficiently safe distance is kept!</i>• <i>During transport, any sloping or inclinations may result in the leaking of lubricants, which can result in a risk of chemical burns should they come into direct contact with the skin.</i>• <i>Suspended loads can fall, then there is danger to life do not stand under suspended loads!</i>• <i>Always use suitable lifting tools to load the machine</i>• <i>The machine may only be lifted at the designated holding points</i>

4.2 Transportation of the machine

Before the machine is transported, all points for decommissioning must be carried out.

When driving on public roads, the statutory provisions must be observed!

When driving on public roads, a maximum width of 2.50 m must not be exceeded.

Furthermore, the lighting should be checked before every journey.

The machine must be cleaned of coarse dirt.

The following points must be observed before driving on public roads.

Checklist:

- The lighting is OK
- Retract the rear extension when traveling empty
- Secure goods during transport
- Crane supports retracted
- Crane position for transport
- Release the parking brake

5 Set up of the machine

5.1 Safety instructions for installation of the machine

<h1>WARNING</h1>	
	<p style="text-align: center;"><u><i>Risk of injury in the event of improper installation of the machine!</i></u></p> <ul style="list-style-type: none">• <i>Check the machine for transport damage before each installation!</i>• <i>Install the machine on level and solid ground!</i>• <i>Use the supporting legs of the machine!</i>• <i>Ensure that nobody is endangered by the installation!</i>• <i>The work area must be fully visible. Nobody is allowed to be in the danger area of the crane. (25m)</i>• <i>The parking brake of the towing vehicle must be applied while loading on sloping terrain.</i>• <i>Avoid loading on uneven terrain</i>• <i>The machine may only be operated if it is in perfect condition!</i>• <i>The PTO shaft must not bend too much.</i>

5.2 Duties before starting operation

<h1>NOTICE</h1>	
	<p><u>Conduct the following actions before starting operation:</u></p> <ul style="list-style-type: none">• <i>Check safety devices for functionality</i>• <i>Before starting work, check that all bolts and screw connections are tight!</i>• <i>Check hydraulic connections and hydraulic oil level</i>• <i>With outside temperatures under 0° Celsius, allow the machine to idle without load for approximately 5 minutes.</i>• <i>Before starting, check the electrical connections / hydraulic connections and the hydraulic oil level.</i>• <i>The PTO shaft protection must be secured against turning.</i>

5.3 Electrical supply

The safety lighting is supplied with power via a 7-pin plug which is connected to the towing vehicle. Safety lighting includes indicators, taillights and brake lights.

The functionality of the lighting systems must be checked before each journey.

Never perform work on electrical systems if you do not have the necessary technical expertise!

5.4 PTO drive

Depending on the model, the timber trailer can be operated via the tractor's hydraulics or by a self-supply by means of a hydraulic oil pump.

If you have the timber trailer version with self-supply via PTO drive, some important points must be observed for commissioning.

When you connect the PTO shaft, make sure that it engages at the connection points and cannot come loose.

Furthermore, the angle of the cardan shaft must be observed when assembling. The correct setting can be found in the operating instructions for the cardan shaft.

We recommend running the machine with a PTO rotation speed of 440 rpm to operate.

5.5 Tractor hydraulics

Connect the hydraulic hoses of the timber trailer to a double-acting control unit of a towing vehicle.

5.6 Crane support

To prevent serious personal injury and damage to the machine, the machine must always be set up on a level and firm ground and the following instructions must be followed exactly.

The crane supports are to be used for every loading activity without exception, otherwise the vehicle can easily tip over.

As soon as the hydraulic oil pump is activated, the supports can be extended. In the case of tractor hydraulics connections, these must be coupled to the tractor and the corresponding tractor valve operated.

If the ground is very soft, generous plates must be placed under the crane supports. This is the only way to prevent the support feet from sinking in.

<h1>WARNING</h1>	
	<p><u>The majority of all accidents with the timber trailer are due to a non-existent or improper support.</u></p>

The 2 shorter levers between the crane control levers are used to extend the supports. One for each support. They should be extended so that the towing eye lifts the tractor slightly.

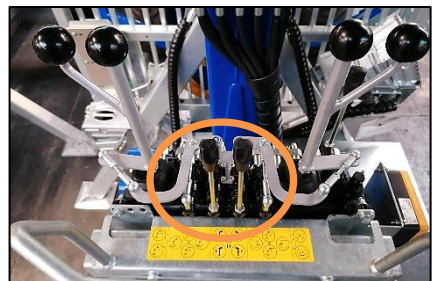

5.7 Extendable frame (mechanically)

Many timber trailers are equipped with an extendable frame. No screwing work is required to extend the trailer. Lift the frame slightly and pull it back until it snaps into place.

The easiest way to do this is to use the crane. However, care should be taken here because the crane has enough power to severely damage or bend the extension.

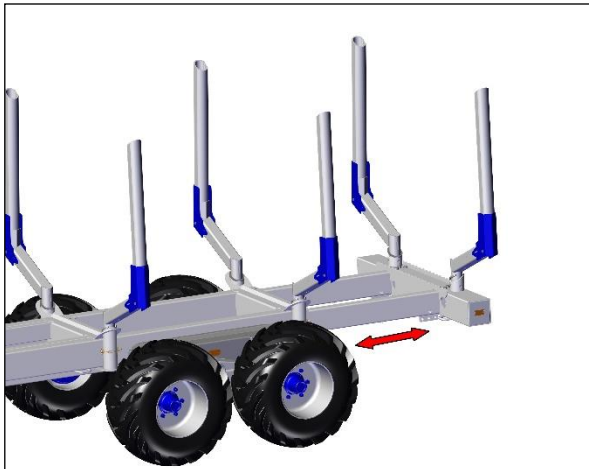

5.8 Extendable frame (Telematic)

A timber trailer can optionally be equipped with a hydraulically telescopic frame. A double-acting control unit on the tractor is required for this. The frame can be hydraulically extended or shortened by 900mm between the front bars and the axle.

5.9 Standing platform

The standing platform is in the transport position while driving and must be folded out for work.

When using the platform in the folded state, there is no hold and there is a high risk of accidents.

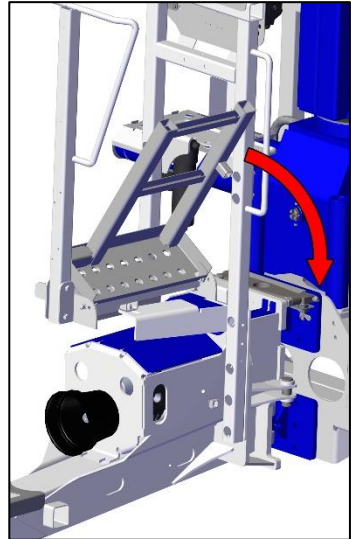

5.10 Parking brake

To release the parking brake, there is a screw on the rear of each axle rocker.

Unscrew this screw with the crank provided (counter clockwise) to release the brake.

The RW5 and RW8 have the option of an overrun brake. With this optional equipment, a handbrake lever serves as a parking brake.



5.11 Swap bodies

With the right attachment, the trailer can also be used for other purposes.

For example, for the transport of brushwood and round bales.

In order to convert the timber trailer for transporting brushwood, the brushwood trays must be lifted onto the timber trailer with the crane and hooked onto the stanchions.

The stanchions must be removed for the other transport attachments. Lighter swap bodies can be lifted into the post slots with the crane. In the case of heavier superstructures, it is possible to set them up on support feet and slide the timber trailer underneath. The supports can then be released so that the swap body is positioned in the post slots.

If you have a timber trailer with a mechanical or hydraulic extension, these must be adjusted so that the stanchion slots are compatible with the swap body.



6 Operation

6.1 Safety instructions during operation

<h1>DANGER</h1>	
	<p style="text-align: center;"><u>Risk of injury while operating!</u></p> <ul style="list-style-type: none">• <i>Keep a sufficiently safe distance away from moving machine parts!</i>• <i>Illuminate the workplace sufficiently!</i>• <i>Mechanically lock the pivoting drawbar on public roads!</i>

<h1>WARNING</h1>	
	<p style="text-align: center;"><u>Risk of injury while operating!</u></p> <ul style="list-style-type: none">• <i>Care must be taken to ensure that only the operator is at the control console.</i>• <i>Ensure that nobody is in the danger area and that a sufficiently safe distance is kept!</i>• <i>It must be ensured that there are no blind spots and that the entire workplace can be seen.</i>

<h1>CAUTION</h1>	
	<p style="text-align: center;"><u>Tripping over parts lying around!</u></p> <ul style="list-style-type: none">• <i>All parts that do not belong to the machine are to be removed from its area.</i>

CAUTION



Risk of injury while operating

- *Only one person may work on the machine at a time!*
- *Make sure that no other people are in the area of the machine.*
- *Wear protective goggles, hearing protection, protective gloves and safety shoes with steel caps!*

6.2 Important instructions during operation

NOTICE



- *The timber trailer may not be used in rain, snowfall or storm.*
- *Before turning the machine on, make yourself familiar with the correct conduct in the event of a failure.*
- *Before the turning the machine on, perform the points cited in the section "Duties before starting operation".*
- *After switching off the machine, the working steps from the following section "Shutdown" must always be carried out.*
- *If the operating personnel leave the machine so that it is unattended, it must be switched off and secured against unauthorised restarting.*

6.3 Hydraulic braking system

The hydraulic brake system is operated by the corresponding single-acting control unit on the tractor. For this it is necessary that the brake hose is connected to the control unit of the tractor.

The brake control valve is located on the brake line to adjust the brake strength. Here you can set whether the trailer is empty, half full or fully loaded.

If the brake is not operated, the brake line must be depressurized. (Float position)

Serious accidents can occur if the braking force is incorrectly set. If the braking force setting is too low (lever on empty, but wagon full), the logging wagon begins to push and significantly increases the braking distance.

If the braking force is set too high (lever on full, but car empty), the tires can block completely and extend the braking distance again.

In addition, heavy tire wear is to be expected in a small area.



6.4 Air brake system

The compressed air brake system works with 4 piston brake cylinders.

First attach the two compressed air lines to the connections provided on the towing vehicle.

As soon as these are connected, the compressed air tank on the timber trailer is filled via the supply line (red).

If the brake is now activated on the towing vehicle, air flows through the brake line (yellow) and the trailer brakes with the air from the tank.

If the timber trailer is separated from the tractor, it brakes automatically with the air from the tank.

6.4.1 Release valve:

If the trailer is to be moved with a tractor without a compressed air system, the release valve (1) must be actuated.

If the trailer is parked again, it must be braked manually with the release valve.

This can be repeated up to 8 times before the tank is empty and the car can no longer be braked.

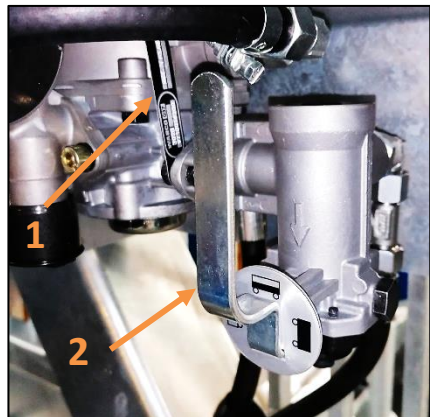

6.4.2 Load dependant brake booster:

In the case of an air brake system, the current state of charge must be set. This is done on the lever next to the release valve (2). You have to set whether the timber trailer is full, half full or empty.

Depending on the setting, the car is braked more or less when braking.

This must be set correctly before the start of the journey, otherwise the braking force will not be properly dosed and the tractor unit may break away when braking.

6.5 Combined brake system (hydraulic and airbrake)

Only a single brake system may be connected to the towing vehicle for the trailer to operate properly.

When operating with the hydraulic brake, it is necessary to completely drain the compressed air from the compressed air brake system.

When operating with the compressed air brake, make sure that the hydraulic brake is completely released. For this it is necessary that the brake hose of the hydraulic brake is connected to the unpressurized return of the tractor.

6.6 Cable winch (optional):

With the winch, heavy pieces of wood can be pulled in and lifted without any problems.

It is controlled via a radio remote control.

In order to be able to pull out the rope, it is only necessary to switch on the return of the winch. The drive is disengaged and the rope can be easily pulled out. The winch comes with skidding tongs as standard. This is applied to the wood and the winch is switched to advance.

It is particularly important to ensure that neither you nor other people are in the area of the rope. A sufficiently large safety distance must also be maintained. A good support of the trailer in the pulling direction is essential. The timber can then be conveniently loaded onto the timber trailer using the crane

If you noticed during operation that the rope was damaged, it must be replaced immediately.



6.7 Crane position for transport

Unloaded driving:

When driving without a load, make sure that the crane is retracted and rests on the frame.

The grapple must be attached to the frame and secured.

Loaded driving:

The best way to secure the crane with a full timer trailer is to attach the grapple to a log. This log should be as far down as possible in the pile so that it is held by the logs above.

If you have all the tree trunks of the same length, the lowest trunk must be offset by approx. Half a meter at the beginning of the loading work so that you can grab it later.

Caution!

Under no circumstances should the crane hang freely in the air. This could lead to serious damage when cornering.



6.8 Swivel drawbar

The swivel drawbar enables better tracking on narrow forest roads / paths. If the swivel drawbar is swivelled correctly shortly before a curve, the trailer will drive in the same lane as the tractor. If this device is not used, the timber trailer moves in a tighter curve radius than the tractor and can thus leave the path and hit trees etc.

Both hydraulic hoses must be connected to the double-acting control unit of the towing vehicle for actuation. The drawbar can be swivelled using the control lever on the towing vehicle.

Fold the swivel drawbar lock up or to the side and secure with the spring bolt. Depending on the model, securing the swivel drawbar can work differently.

The safety device **MUST** be folded in when driving on public roads.

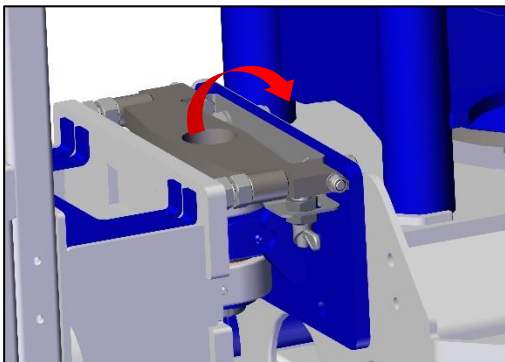

Variant 1

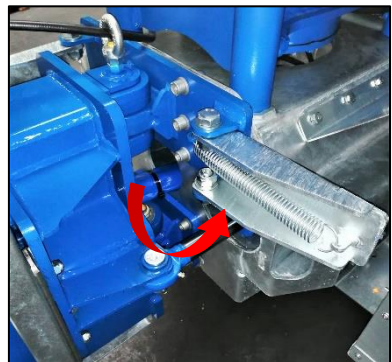

Variant 2

6.9 Wheel hub drive (optional)

It can happen that the tractor or the timber trailer gets stuck or sinks in on uneven terrain. In this case the pure driving force of the tractor is too low or cannot be transferred to the ground.

In order to be able to free yourself from this situation, the wheel hub drive can be switched on. The hydraulic drive acts on the wheels of the trailer and can thus generate the necessary force to be able to continue driving.

In order to activate the drive, the control lever must be moved forwards or backwards and held with the PTO shaft switched on.

The wheel hub drive is speed limited and should only be used for short distances in difficult terrain. Cornering is difficult.

6.10 Stanchion extension (optional)

The stanchion extensions are to be inserted into the stanchions at the top without fastening.

After each unloading check whether all extensions are still in the stanchions, as careless handling of the crane can pull out the short pipe sections.

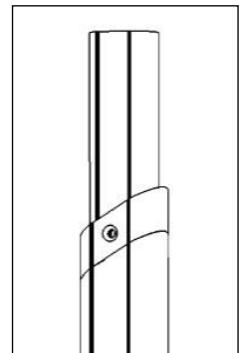

7 Shutdown

7.1 Safety instructions for the shutdown procedure

DANGER	
	<p><u>Risk of injury by being drawn in or caught by moving machine parts!</u></p> <ul style="list-style-type: none">• <i>After the shutdown, wait until all moving machine parts have come to a complete stop!</i>• <i>Keep a sufficiently safe distance away from moving machine parts!</i>

WARNING	
	<p><u>Risk of injury during shutdown!</u></p> <ul style="list-style-type: none">• <i>Care must be taken to ensure that nobody is in the danger area and a sufficiently safe distance is kept</i>

WARNING	
	<p><u>Risk of injury with the switching on of the machine by unauthorised people!</u></p> <ul style="list-style-type: none">• <i>After operation, secure the machine against unauthorised switching on!</i>

7.2 Crane position

If the logging trailer is taken out of service, the crane must be parked in a safe position. This means that the crane must not be parked while it is floating (it may sink) and that it does not become a trip hazard or obstacle. The crane should preferably be put down in the transport position. (see: **6.8 Crane position for transport**)

7.3 Switch off drive

7.3.1 PTO drive

Switch off the PTO shaft drive on the tractor and then switch off the tractor. Secure it against being switched on again and disconnect the PTO connection.

7.3.2 Tractor hydraulics

When you have finished your work, turn off the tractor. Switch the double-acting valve on the tractor so that the hoses are depressurized. You can now disconnect the hoses from the timber trailer.

7.4 Parking brake

If the timber trailer is detached, the parking brake must be activated.

Use the crank provided and turn the threaded rod clockwise. The threaded rod is located at the rear of each axle rocker.





8 Maintenance

During the first month every week all screws and connections should be checked for tightness.

8.1 Safety instructions during maintenance

DANGER	
	<p><u>Risk of severe injury by switching on the driving mechanism during maintenance work!</u></p> <ul style="list-style-type: none">• <i>Switch off machine!</i>• <i>Secure against unintentional restart!</i>

DANGER	
	<p><u>Danger of life from electric shock!</u></p> <ul style="list-style-type: none">• <i>Work on electrical systems may only be carried out by qualified personnel!</i>

CAUTION	
	<p><u>Risk of injury! Scalding due to hot machine components and media!</u></p> <ul style="list-style-type: none">• <i>Allow the machine to cool down to ambient temperature before carrying out any maintenance.</i>

CAUTION	
	<p style="text-align: center;"><u>Lubricants!</u></p> <ul style="list-style-type: none">• <i>Avoid contact with skin and eyes.</i>• <i>Use the appropriate protective equipment (gloves, safety glasses)</i>• <i>Use appropriate collection containers.</i>• <i>Immediately clear up any oil that has leaked.</i>

8.2 Important instructions during maintenance

NOTICE	
	<ul style="list-style-type: none">• <i>Immediately exchange all impaired machine parts.</i>• <i>Only use original replacement parts.</i>• <i>Only use the fuels specified.</i>• <i>Self-securing bolts and nuts are always to be replaced.</i>• <i>All fuels and lubricants that are not re-used are to be disposed of in an environmentally sound manner.</i>• <i>The installation of incorrect replacement or wear parts can result in serious motor damage.</i>• <i>fire extinguishers at the ready.</i>• <i>Never enable the machine without the factory-provided safety equipment for the operation.</i>• <i>It is strictly forbidden to remove safety instructions attached to the machine.</i>• <i>Do not carry out any repairs if you are not qualified to do so.</i>

8.3 Instructions for work on electrical equipment

All work on the electrical equipment (e.g., lighting) of the machine may only be carried out by trained electricians.

Check electrical equipment regularly:

- Reattach loose connections.
- Replace damaged lines or cables immediately.
- During all work on live machine parts or lines, a second person must always be present to disconnect the power supply in an emergency.
- Never clean electrical equipment with water or similar liquids.

8.4 Instructions for work on hydraulic equipment

All work on the hydraulic equipment of the machine may only be carried out by trained specialists.

- Before starting work, depressurise all hydraulic systems / system parts.
- Before starting work, make sure that suitable collecting containers are available for all substances hazardous to groundwater (oils, coolants, etc.).

8.5 Daily maintenance

Check that:

- nothing "abnormal" has occurred on the attachments and hydraulic hoses of the timber trailer.
- no damage or breaks have occurred.
- there are no leaks.

8.6 Duties before finishing maintenance

After the end of any maintenance work and before starting the machine, the following points are to be followed:

- Check that all previously loosened screw connections are secure.
- Check whether all protective devices, covers, container lids, ... that were removed before have been properly reinstalled.
- Ensure that all tools, materials and other equipment used have been removed from the work area.
- Clean the work area and remove any liquids and similar substances that may have leaked out.
- Make sure that all safety devices on the machine are working properly again.
- Check the function of the safety devices. Do not approve the machine for use if the safety devices do not work properly.
- Assemble and secure dismantled protective devices.
- Remove any tools, foreign parts and operating materials that have been left behind.
- Carry out a test run with a functional check of the repaired components.
- Secure the machine against unauthorized switching on if you have not completed the work.
- Working with open flames and smoking is prohibited.

8.7 Cleaning

The machine must be cleaned of dirt after every work and before every maintenance!

8.8 Lubrication plan

The timber trailer should be lubricated every 50 hours of operation.

There are 4 grease nipples on the axle tube (Fig. 2). Two in the middle and one each left and right between frame and tire.

There are also grease nipples on the steering drawbar (Fig. 1). One at the front and one at the rear on the 2 swivel cylinders and one or six at the end of the drawbar, where it is rotatably mounted.

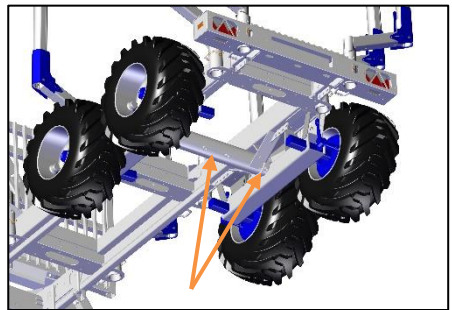
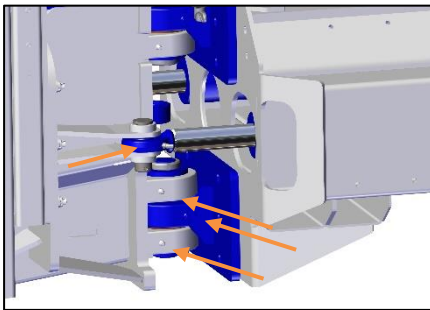

Details on the lubrication points on the crane can be found in the respective operating instructions for your crane.

8.9 Checking the tires

It is important to ensure that the tires have the correct air pressure. The wheel nuts must be tightened to 340 Nm.

Danger! The wheel nuts must be checked and retightened after the first 5 km.

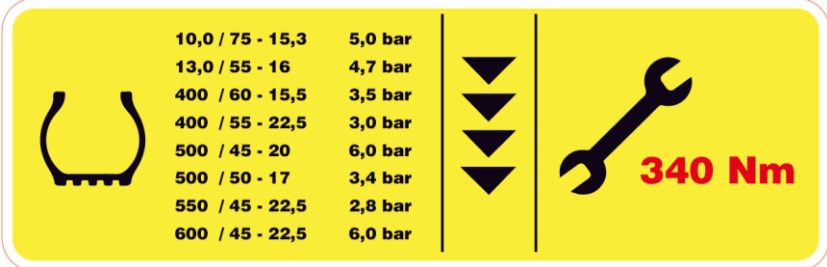

A yellow rectangular sign with rounded corners and a red border. On the left is a black silhouette of a tire. To its right is a table of tire specifications and their corresponding air pressures. Further right are four black downward-pointing triangles. On the far right is a black wrench icon with the text '340 Nm' in red next to it.

10,0 / 75 - 15,3	5,0 bar
13,0 / 55 - 16	4,7 bar
400 / 60 - 15,5	3,5 bar
400 / 55 - 22,5	3,0 bar
500 / 45 - 20	6,0 bar
500 / 50 - 17	3,4 bar
550 / 45 - 22,5	2,8 bar
600 / 45 - 22,5	6,0 bar

8.10 Chassis and Brakes

The bearing play of the wheels must be checked every 50 operating hours and readjusted if necessary. This also applies to the wheel hub drive.

The stroke of the brake cylinder must be checked every 20 operating hours - max. Stroke: 55 mm.

Internal brake cylinders are self-adjusting. The brake must be readjusted for a larger stroke. A specialist workshop is to be visited for this.

8.11 Maintenance work every 250 hours

Check that:

- No brackets or locks are missing.
- the hydraulic hoses are not damaged.
- The timber trailer has not been damaged or broken.
- there are no leaks.

All damaged or worn parts must be repaired or replaced.

8.12 Oil change

The first oil change takes place after 250 operating hours. After that, the oil change must be carried out every 1000 operating hours or once a year. A HVI 46 or equivalent oil must be used as the hydraulic oil. Make sure that a correspondingly large collecting container (min. 80l) is available.

To drain the hydraulic oil, open the drain screw on the tank. When the oil has drained from the tank, close the tank tightly again and fill it with oil. A sight glass is attached to the tank for the fill level. The optimum amount of oil has been reached when half of the display is filled with oil. As a guide value, 40l to 60l depending on the crane and support type can be expected.

After filling, you put the timber trailer into operation and drive back and forth a few times without wood. Check the oil level on the sight glass again and top up with a little more hydraulic oil if necessary.

8.13 Changing Oil filter

The oil filter is located at the bottom left on the standing platform. It should always be changed together with the hydraulic oil.

To:

- Unscrew the outer filter sleeve
- Change the filter cartridge
- Screw the filter sleeve back on.



8.14 Changing the hydraulic hoses:

All hydraulic hoses must be replaced after 5 years due to aging and durability.

Otherwise serious injuries can occur due to damage (brittle areas, etc.) to the hoses.

8.15 Electrical system

All timber trailers are equipped with safety lighting and a 7-pin connector. This safety lighting includes indicators, taillights and brake lights.

Danger! You must check the lighting before every journey on public roads!

Defective lamps can be replaced as follows.

- First unscrew the two screws (1) on the side cover.
- Remove the side cover
- Remove the 2 screws (2) which are screwed to the lighting.
- Pull out the lamp and remove the light glass.
- Change the lamp and put everything back together in reverse order.

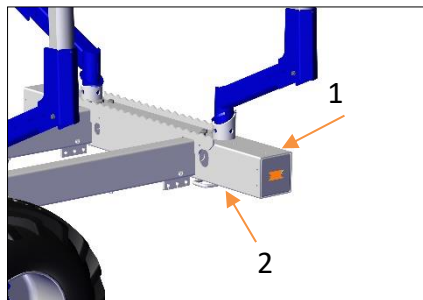

Danger! Always observe the correct wattage when changing the lamp.

9 Guarantee and Warranty

Guarantee Terms 950601:

The Binderberger Maschinenbau GmbH company provides a guarantee for a period of two years on parts that fail to fulfil their intended purpose as the result of material defects or production errors.

A one-year guarantee is provided by our suppliers on goods procured by us, such as wheels, axels and valves. The guarantee comes into force with the delivery date.

The guarantee does not cover failures that are due to normal wear, inattentiveness, incorrect use and incorrect assembly. Hydraulic hoses and couplings are excluded from the guarantee.

Costs that originate within the scope of the guarantee procedure for detaching, assembly and delivery are not refunded. The fault should be repaired upon the mutual arrangement of the customer, the appointed dealer and the Binderberger company. The fault should be repaired following a mutual arrangement between the customer, the appointed dealer and the Binderberger company.

For this, the model of the machine, the production number, the delivery date and the name of the owner, as well as the address, must be indicated. For this, the model of the machine, the production number, the delivery date and the name of the owner as well as the address must be presented.

The guarantee is invalid if the machine deviates from the original implementation, e.g., due to changes, set-up, additional constructions or the replacement of parts that have not been delivered by us. Otherwise, the NL92 delivery regulations are valid.

10 Conduct when dealing with accidents

As a matter of routine, ensure you have up-to-date information about available first aid options.

After the initial care of injured people, immediately inform your supervisor of any personal injuries, damage to the machine or material damages.

In the event of the specific use of emergency vehicles, state the severity of the injury and damage.

In a disaster situation, immediately leave the machine (fire).

Note

In the pursuit of technical advancement, Binderberger Maschinenbau GmbH continually works to improve its products. We reserve the right to make changes from the illustrations and descriptions in this operating manual/replacement parts list. This cannot give rise to any claim to changes on machines that have been already delivered. The technical data, dimensions and weights are not binding.

Errors excepted.

Dealer's stamp:

Name plate:



Maschinenbau GmbH
Fillmannsbach 9
A-5144 St. Georgen am Fillmannsbach
Tel: +43 / 7748 / 8620
Fax: +43 / 7748 / 8620 – 20
office@binderberger.com
www.binderberger.com